

Registered / Eingetragen 05/04/2013

No 002214692-0001



OHIM – OFFICE FOR HARMONIZATION  
IN THE INTERNAL MARKET  
TRADE MARKS AND DESIGNS

## CERTIFICATE OF REGISTRATION

This Certificate of Registration is hereby issued for the Registered Community Design identified below. The corresponding entries have been recorded in the Register of Community Designs.

HABM – HARMONISIERUNGSAMT FÜR  
DEN BINNENMARKT  
MARKEN, MUSTER UND MODELLE

## EINTRAGUNGSRUKUNDE

Diese Eintragungsurkunde wird für das unten genannte eingetragene Gemeinschaftsgeschmackmuster ausgestellt. Die entsprechenden Einträge sind in das Register für Gemeinschaftsgeschmacksmuster aufgenommen worden.

*The President / Der Präsident*

*António Campinos*



- 21 002214692-0001  
25 EN - DE  
22 05/04/2013  
15 05/04/2013  
45 09/04/2013  
11 002214692-0001  
72 Jian WU  
73 NANTONG SKYFIX CO., LTD  
38, Jiaoyu Road  
NANTONG CITY, JIANGSU PROVINCE  
REPÚBLICA POPULAR DE CHINA  
74 HUASUN PATENT ATTORNEYS AND ATTORNEYS AT LAW  
Friedrichstr. 33  
D-80801 München  
ALEMANIA  
51 08 - 08  
54 **BG** - Скоби за маркучи и тръби  
**ES** - Abrazaderas para mangueras y tuberías  
**CS** - Svorky na hadice a trubky  
**DA** - Spændbøjler til slanger og rør  
**DE** - Rohre (Schellen für Schläuche und - )  
**ET** - Vooli- ja toruklambrid  
**EL** - Διατάξεις συγκράτησης για εύκαμπτους σωλήνες και σωλήνες  
**EN** - Clamps for hoses and pipes  
**FR** - Brides pour tuyaux  
**IT** - Flange per tubi  
**LV** - Skavas šļūtenēm un caurulēm  
**LT** - Žarnų ir vamzdžių veržtuvai  
**HU** - Tömlőszorító és csőbilincsek  
**MT** - Rbit għall-manek u għall-pajpijiet  
**NL** - Klemmen voor buizen en slangen  
**PL** - Zaciski do węży i rur  
**PT** - Braçadeiras para mangueiras e tubos  
**RO** - Cleme pentru furtunuri și țevi  
**SK** - Svorky na hadice a rúry  
**SL** - Objemke za gumijaste cevi in vodovodne pipe  
**FI** - Letkujen ja putkien kiinnikkeet  
**SV** - Klämmor för slangar och rör  
-  
**BG** - Втулки за тръбопроводи  
**ES** - Abrazaderas para tuberías  
**CS** - Objímky na trubky  
**DA** - Rørmuffer  
**DE** - Klemmen (Rohr- )



- ET** - Torumuhvid
- EL** - Δακτύλιοι για σωλήνες
- EN** - Collars for pipes
- FR** - Colliers pour tuyaux
- IT** - Collari di tubi
- LV** - Cauruļu ieliktni
- LT** - Vamzdžių žiedai
- HU** - Csőkarimák
- MT** - Kullari għall-pajpijiet
- NL** - Pijpbeugels
- PL** - Kolnierze do rur
- PT** - Braçadeiras de canos
- RO** - Manșoane pentru țevi
- SK** - Objímky na rúrky
- SL** - Objemke za cevi
- FI** - Putkien yhdistämisholkit
- SV** - Kragar för rör

55

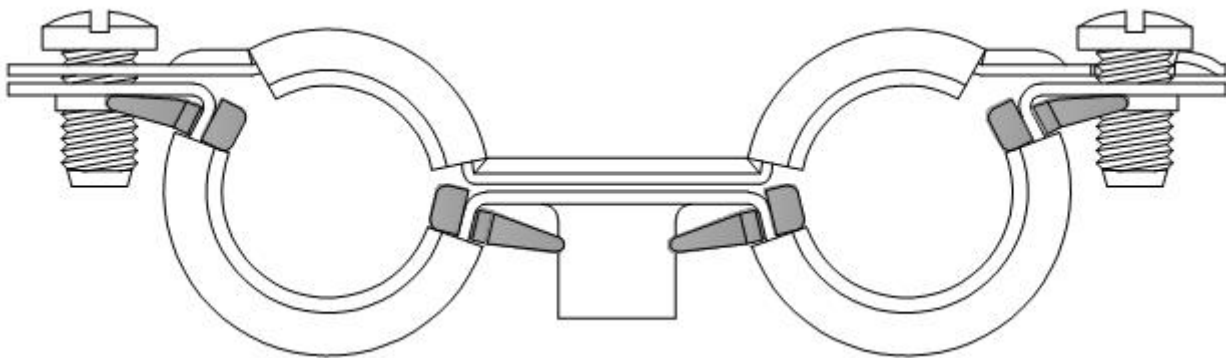

0001.1

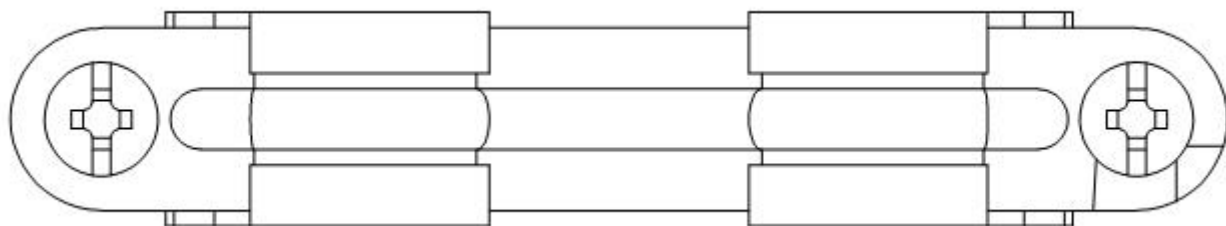

0001.2

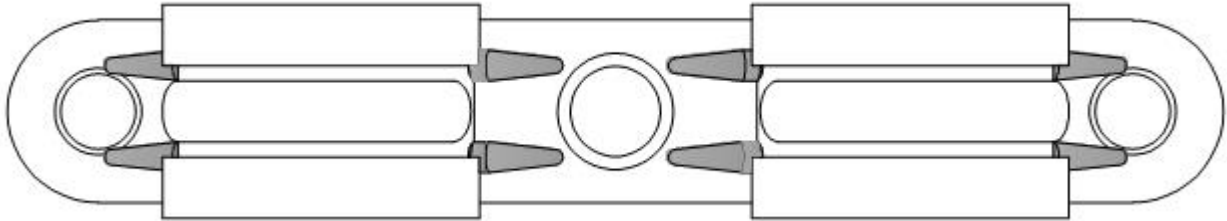

0001.3

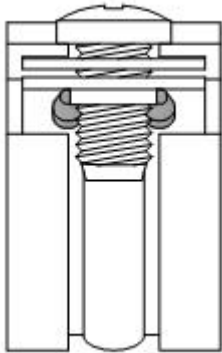

0001.4

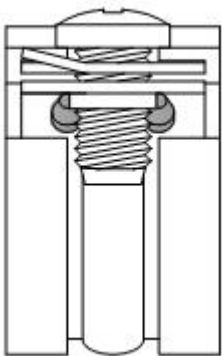

0001.5

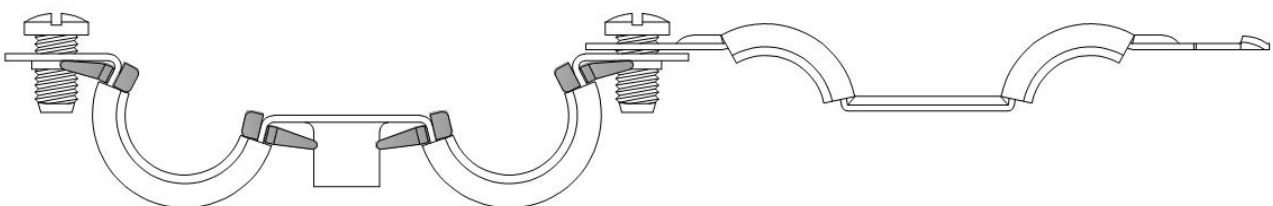

0001.6

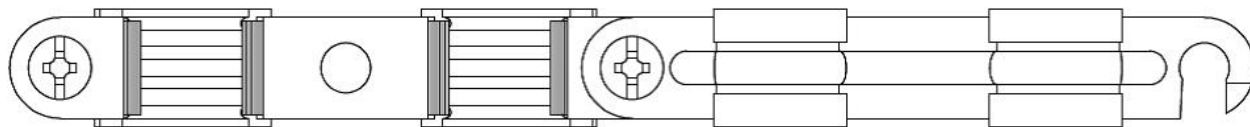

0001.7